

Article number: 20291130200L2SCR

Description: E+G Linear actuators - GN 291.1-30-200-L2-SCR

## Measures

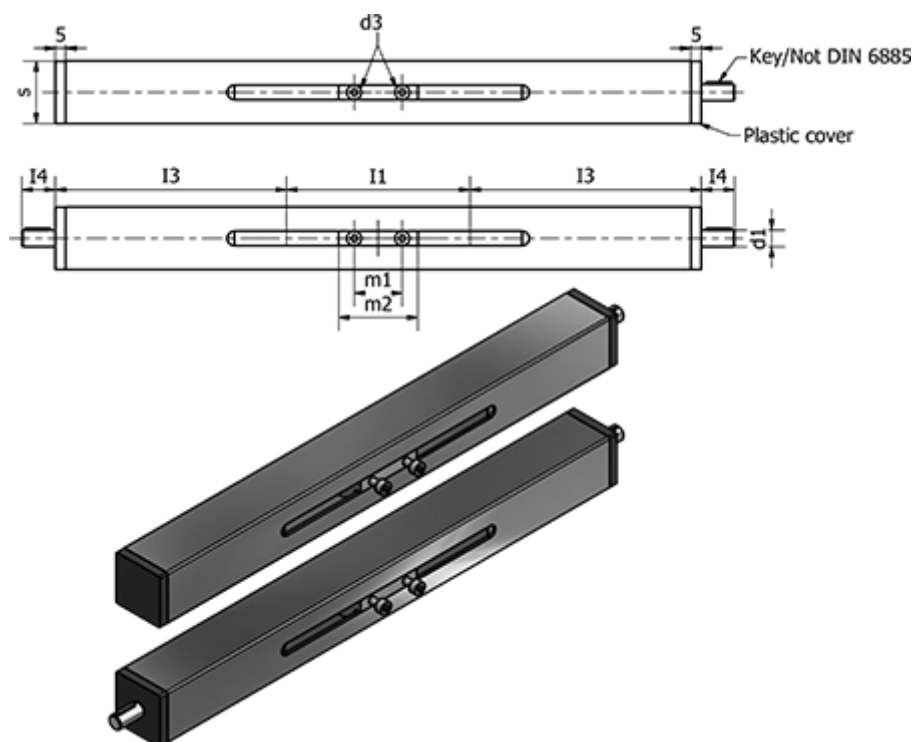

d1 f7 = 8

d2 = M4

I1 = 200

I2 = I2+210

I3 = 105

I4 = 16

m1 = 23

m2 = 38

Max. travel = 1250

s = 30

Shaft key DIN 6885 = A2x2x12

Shaft thread = TR14x4